

trusscore Installation Guide

SlatWall

Important notice

IMPROPER STORAGE, INSTALLATION OR INADEQUATE GAPS FOR EXPANSION AND CONTRACTION MAY CAUSE WARPING, BUCKLING AND PERMANENT DAMAGE OF THE MATERIAL!

Start here

- Please read this guide completely before installation.
- Follow the recommended fastening and installation procedures.
- Improper handling, storage or installation may cause buckling and permanent damage of the products which will void any warranty.
- The purchaser is solely responsible for determining the suitability for use or application of Trusscore SlatWall and all components and whether the materials meet all requirements of applicable local building and safety codes for the specific application.
- The purchaser is solely responsible for ensuring that selected fasteners and any support structure (e.g. timber frame, masonry walls etc.) receiving these fasteners, are structurally adequate for their purpose in fixing the panels in place, for the required duration of their use.
- Be sure to wear adequate PPE (i.e. eye and hearing protection.)

Recommended

- Work table
- Tape measure
- Hammer
- Square
- Chalk line
- Level
- Utility knife
- Tin snips
- Caulking gun
- Putty knife
- Sliding radial arm saw**
- Drill/screw gun
- Ladders and/or scaffolding
- Stud finder

** Use a fine tooth blade (12 to 19 teeth per inch) with the blade installed in the reverse direction. Some applicators prefer hand-held circular saws with a similar blade installation.

Fastener

Use only corrosion-resistant (galvanized, stainless steel or aluminum) screws with a minimum head diameter of 3/8".

1. For masonry, use Tapcon Screws - 3/16" diameter Phillips Pan Head or similar, with 1/4" stainless steel washers.
2. For wood framing, use stainless steel screws - #8 Phillips Pan Head or similar.
3. For metal studs, make sure to use self-tapping screws instead of wood screws.
4. The recommended fasteners length is 1 1/4" for wood studs or masonry, 1 1/2" or 2" for drywall installation and 2 1/2" of furring strips are used for strapping.

Do not use staples! Do not use power nailing guns!
It is recommended to pre-drill the holes if the panels are longer than 4'.
Over tightening of fasteners may damage panels and void warranty.

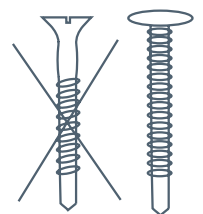

Preparation

1. Check surfaces for straightness and install strapping where necessary. Make sure that all vapor barriers etc. are installed to code prior to Trusscore SlatWall being installed.
2. Install wood blocking around all openings to properly support trims.
3. It is recommended that Trusscore SlatWall starts and finishes on studs (16" apart to supports 75 lbs per square foot.) Locate all studs between start and finish with the stud finder, if installing on drywall.

Basic recommendations

1. Trusscore SlatWall panels are to be used in HORIZONTAL installations only
2. Leave a minimum of 1/4" clearance at ends of all panels and trims to allow for expansion and contraction. Start at the center of the panel and work outwards.
3. Fasteners should penetrate a minimum of 1" into solid backing and be no more than 16" apart (for masonry installations) and at least 4" from the end of the panel. Before fastening, double-check to make sure that the Trusscore SlatWall panel is interlocked along its entire length. Keep the joints uniform to ensure that all joints remain parallel.
4. Use a one-part, neutral cure silicone sealant to seal all corners, to seal around all fixtures and to repair small holes. The sealant color should match Trusscore SlatWall.

Installation guide & integrating Trusscore SlatWall

1. Trusscore SlatWall panels can be installed with Trusscore Wall&CeilingBoard:

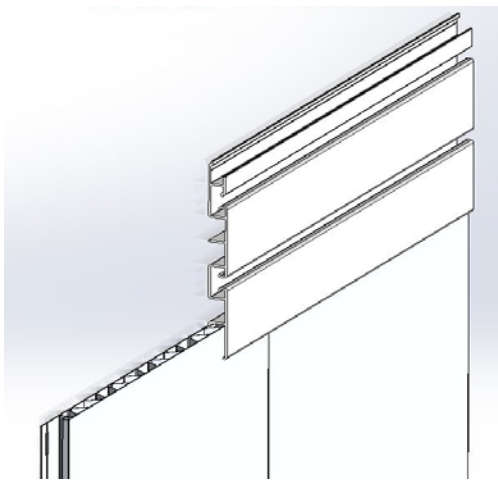

2. Install vertical J trims, H Channel Snap-In Kits, or Inside Cove Corner Snap-In Kits at the desired intervals.

3. To install the first Trusscore SlatWall panel, insert one end of the panel (left to right) into the other vertical J trim. Make sure the panel sits properly on top of the Trusscore Wall&CeilingBoard. If the panels are longer than 4' it is best to have the help of a second person.

4. Screw through the upper cavity of the panel into each stud (16" apart). Screws at either end of the panel will screw through the J trim and into the stud. This will hold the J trims.

5. Next panel - insert one end of the panel into one of the vertical J trims, curve your panel and insert into the opposite side J trim. Slide it down until it interlocks with the previous panel as shown in the picture below. Make sure you screw the panels into the stud.

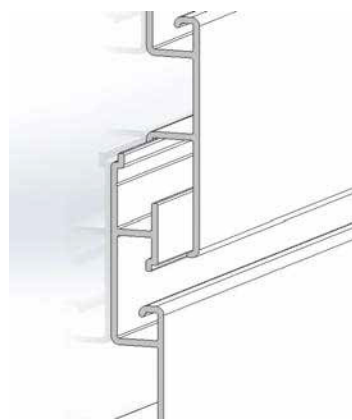

6. Repeat until your section is done. Properly interlocked panels will conceal previous panel's installation screws.

7. Top trim - can be Trusscore SlatWall Top Cap. It can also be a J trim, if the ceiling is not finished or the installation does not reach the ceiling or Inside Cove Corner Snap-In Kit.

8. If installing without Trusscore Wall&CeilingBoard (floor to ceiling), begin by installing the J trim along the bottom of the wall. If using a J trim, be sure to drill 1/4" dia. drain holes in the bottom of the J trim at 16" on center for drainage.

Cleaning

1. To remove common dirt and grime and maintain your Trusscore Wall&CeilingBoards beautiful appearance, wash using a long handled sponge or soft bristly brush and a mild cleaning solution. If the dirt is hard to remove, wipe clean with a solution of:

- 1/3 cup laundry detergent (e.g. Tide®)
- 2/3 cup Tri-sodium phosphate (e.g. Soilax®) - 1 gallon of water.

2. Protect eyes and skin from direct contact with cleaning agents.

**WARNING: Follow the precautionary labeling instructions on all cleaning agent containers.

3. For removal of stubborn stains and other marks, contact your nearest Trusscore representative for recommendations.

THE MANUFACTURER AND DISTRIBUTOR ARE NOT RESPONSIBLES FOR PROBLEMS RELATED TO EXPANSION DUE TO TEMPERATURE FLUCTUATIONS. IF WIDE TEMPERATURE FLUCTUATIONS EXIST IN THE AREA OF THE TRUSSCORE INSTALLATION, ALLOW FOR EXPANSION AND CONTRACTION GAPS IN MOLDINGS AND PERIMETER. BEFORE INSTALLATION, TRUSSCORE WALL&CEILINGBOARDS AND TRIMS SHOULD BE ACCLIMATIZED TO MINIMIZE EXPANSION AND CONTRACTION ISSUES.

Specifications

Trusscore SlatWall comes in standard 4 ft. and 8 ft. lengths.

If properly installed, Trusscore SlatWall supports up to 75 lbs per square foot of load.

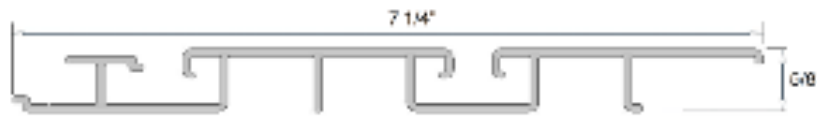

Hook (hardware) Detail

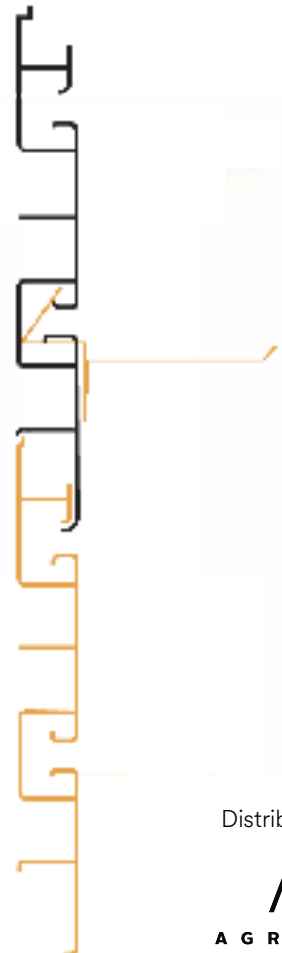

Trims & Flashing

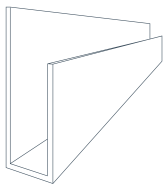

J Trim
3/4"

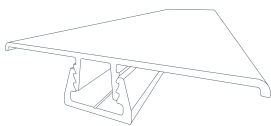

H Channel
Snap-In Kit

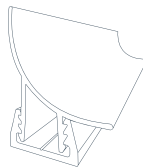

Inside Cove Corner
Snap-In Kit



Top Cap



Distributed by



450 994-3130